

FIREYE EP260, EP265, EP270 PROGRAMMER MODULE

WITH SELECTABLE OPERATION
FOR USE WITH THE
FIREYE FLAME-MONITOR™ CONTROL



DESCRIPTION

The Fireye EP260, EP270 (early spark termination), or EP265 (pilot stabilization) programmer modules are used with the FLAME-MONITOR Burner Management Control System (P/N E110). Several operational characteristics of the programmer (with Engineering code 28 or later, e.g. 9414-28) are determined by six (6) dipswitches located on the side of the programmer. These characteristics include extended purge timing (dipswitches 3, 4, 5), and the option requiring the 3-P running interlock circuit to be proven open at the start of the operating cycle (dipswitch 6). Dipswitches 1 and 2 are inactive.

The EP260, EP265, EP270 programmers provide start-up programming, safe-start check, and flame monitoring supervision. They insure proof of low fire position, and fuel valve end switch safety checks. The control is designed to initiate a safety lockout if any of these circuits are open at the improper point in the control cycle. A running interlock circuit on the FLAME-MONITOR system constantly monitors the limit switches, air flow switches, and fuel pressure switches through the programmer. The programmer will recycle if the running interlock circuit (3-P) is opened during the firing cycle.

The programmer module will de-energize all fuel valve circuits within four (4) seconds (max.) following a flame failure [two (2) seconds for the EP265], or at the end of the pilot trial for ignition period if no flame is detected. An alarm circuit will be energized following a safety lockout.

The programmer module includes an RJ45 style connector to interface with an integral or remote alpha-numeric display (P/N ED510). It includes two (2) additional RJ style connectors to connect to an E500 Communication Interface in a multi-drop configuration. The programmer will also communicate with the E500 via the standard ED550 cables to provide backward compatibility.

All EP programmers come equipped with built-in modbus-rtu communications. Refer to bulletin E-1101 for complete details.

The programmer is the heart of the FLAME-MONITOR System and features a plug-in design for ease of installation. It is micro-processor based and stores burner cycles, burner hours, system hours, and lockout history (with burner cycle and burner hour time stamp) which are accessible via the ED510 alpha-numeric display, E500 Communication Interface or Modbus Communications. If replaced, the new programmer card will begin accumulating a new history.

Refer to Bulletin E-1101 for detailed information on the FLAME-MONITOR System.



INSTALLATION



WARNING: To prevent shock hazard, remove power from the system wiring base before proceeding. Remove control from the wiring base before proceeding.

The EP programmer modules are used with the Fireeye EB700 base chassis. They are installed in the chassis by inserting the EP programmer module into the second slot on the control. This slot is marked "Programmer Module" on the side of the chassis.

The programmer module is designed to fit only in the proper slot. It cannot be snapped into place if inserted in the wrong location. **DO NOT FORCE THEM.**

An amplifier model, display module (ED510) and flame scanner are also required for the FLAME-MONITOR control.

The EP260, EP265, and EP270 programmers are compatible with both the ED500 and ED510 display modules. See "Programmer and Display Module Compatibility" later in this document.

The Engineering code is located on the back side of the board in the lower right hand corner.

APPROVALS

Underwriters Laboratories Inc.:

MCCZ File MP 1537

Controls, Primary Safety - Listed

MCCZ2 File MP1537

Controls, Primary Safety - Component

MCCZ7 File MP1537

Controls, Primary Safety Certified for Canada

MCCZ8 file MP1537

Controls, Primary Safety Certified for Canada - Component

ACCEPTABLE BY: INDUSTRIAL RISK INSURERS (I.R.I.)

FACTORY MUTUAL (FM) APPROVED



WARNING: This equipment generates, uses and can radiate radio frequency energy, and, if not installed and used in accordance with the instruction manual, may cause interference to radio communications. It has been tested and found to comply with the limits for a Class A computing device pursuant to Subpart J of Part 15 of FCC Rules, which are designed to provide reasonable protection against such interference when operated in a commercial environment. Operation of this equipment in a residential area is likely to cause interference, in which case the user, at his own expense, will be required to take whatever measures may be required to correct the interference



ORDERING INFORMATION

PART NO.	PURGE	IGNITION TIMING			FFRT ²
			PTFI	MTFI	
EP260	30 Sec. ¹	Term 5	10 Sec.	10 Sec.	4 Sec.
		Term 6	10 Sec.	15 Sec.	
EP265	30 Sec. ¹	Term 5	10 Sec.	—	2 Sec.
		Term 6	10 Sec.	15 Sec. ³	
EP270	30 Sec. ¹	Term 5	5 Sec.	—	4 Sec.
		Term 6	10 Sec.	10 Sec.	
EP270W	30 Sec.	Term 5	5 Sec.	—	4 Sec.
		Term 6	10 Sec.	10 Sec.	

¹ Purge timings are adjustable. See "Dipswitches — Purge Timing."
² FFRT is the Flame Failure Response Time.
³ During MTFI, terminal 6 is energized for 5 seconds (pilot stabilization) before energizing terminal 7 for 10 seconds (EP265 only).

NOTE: The EP260, EP265, and EP270 has a recycle running interlock circuit (3/P).



WARNING: While all controls are mechanically interchangeable because they mate with a common wiring base, you must select the correct model for your application. Inappropriate application of a control could result in an unsafe condition hazardous to life and property.

TIMING CHARTS

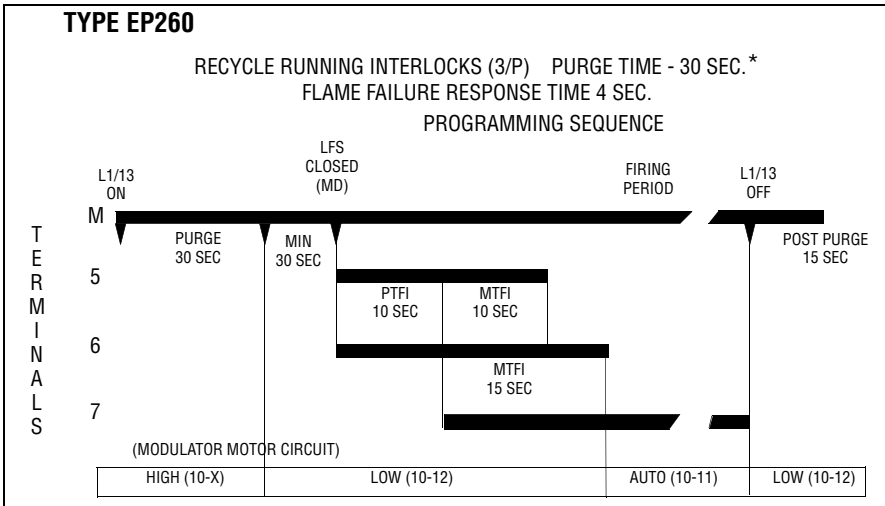

DIPSWITCH SETTINGS					
1	2	3	4	5	6
INACTIVE		Down	Down	Down	Down

* Purge timings are adjustable.

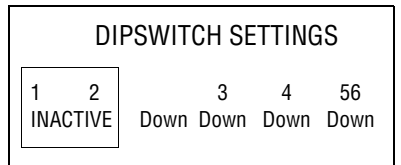
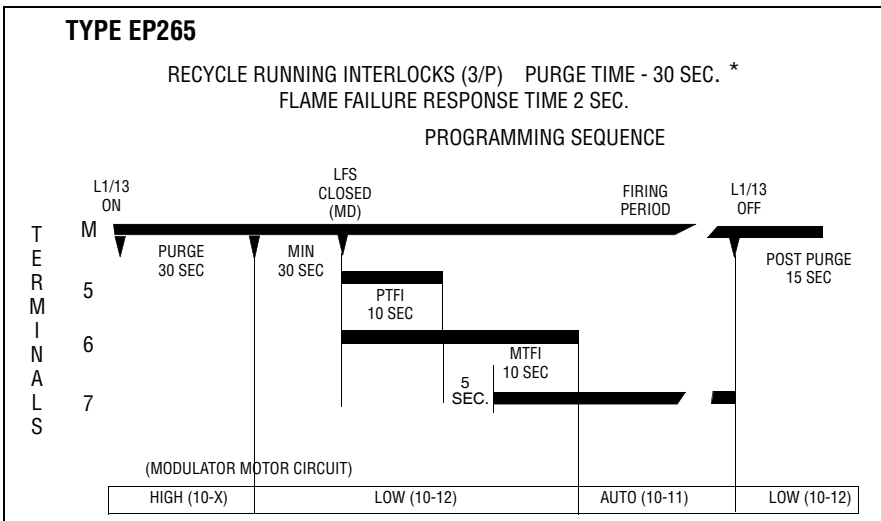
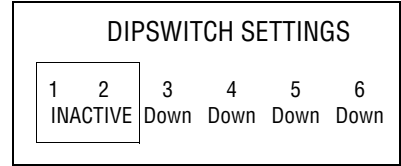
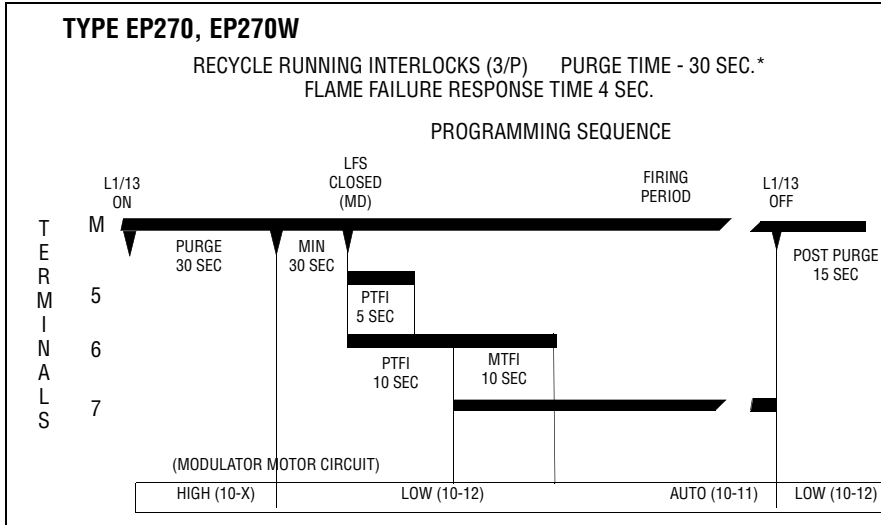

*PURGE TIMINGS ARE ADJUSTABLE

DIPSWITCHES FOR SELECTABLE OPERATION:

Several operational characteristics of the EP260, EP265, EP270 programmer modules are determined by six (6) dipswitches located on the side of the programmer. These characteristics include purge timing (dipswitches 3, 4, 5) and the option requiring the 3-P running interlock circuit to be proven open at the start of the operating cycle (dipswitch 6). Dipswitches 1 and 2 are inactive.

The dipswitches on the EP270W are not functional.

EIGHT (8) HOUR BURN-IN PERIOD OF DIPSWITCH FUNCTIONS

The EP Programmer modules have a set of six (6) dipswitches located on the side of the programmer that allow the user to modify various functions associated with the operation of the programmer (e.g. purge timing, prove 3-P circuit open-to-start, etc.). **THESE FUNCTIONS WILL BECOME PERMANENT AFTER THE CONTROL HAS BEEN POWERED FOR EIGHT (8) HOURS.** After this eight-hour burn-in period, changing the position of the dipswitches will not change the operation of the programmer.

The user can bypass the burn-in period via the ED510 display module. Use the SCROLL and MODE key to select the "Programmer Set-Up" sub-menu (Refer to bulletin ED-5101) and then the SCROLL key to display the prompt:

**PRESS RESET TO
ACCEPT SETTINGS**

Press the Reset Key at this prompt and the screen will display:

**YOU AGREED TO
ACCEPT SETTINGS**

After the above key sequence is completed, changing the position of the dipswitches will not change the operation of the programmer.

LOCKOUT HISTORY

The code 35 programmers now allow the user to reset the programmer's history to zero in the following manner:

To reset the programmer's history to zero:

1. Open the operating control.
2. Press the SCRL key until the ED510 screen displays SYSTEM INFO.
3. Press the MODE key and the screen displays AVG PILOT FLM 22.
4. Press the SCRL key until the screen displays:

**PRESS RESET TO
CLEAR HISTORY**

5. Press the RESET key to reset Burner Cycles, Burner Lockouts, System Hours, and Lockout History to zero.



WARNING: THE INAPPROPRIATE SELECTION OR APPLICATION OF A PROGRAMMER MODULE COULD RESULT IN AN UNSAFE CONDITION HAZARDOUS TO LIFE AND PROPERTY. The various programmer modules (EP160, EP260, and EP380) are interchangeable because they plug into a common chassis. Changing the dipswitches modifies the operation of each programmer module. Care should be taken to insure the proper dipswitch settings. Selection of the programmer module and setting the dipswitches for a particular application should be made by a competent professional, such as a Boiler/Burner technician licensed by a state or other government agency, engineering personnel of the burner, boiler, or furnace manufacturer (OEM) or in performance of duties based on information from the OEM.

FRONT COVER

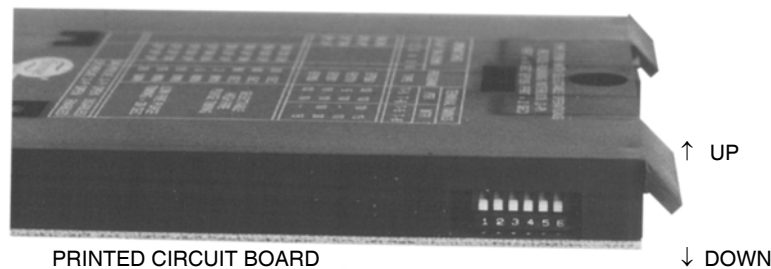

DIPSWITCHES 1 & 2 - INACTIVE



DIPSWITCHES 3, 4, & 5 - PURGE TIMING:

Dipswitches 3, 4, & 5 determine the purge timing for the programmer module. Purge timings are selectable from 30 seconds to 30 minutes. On the EP260, EP265, EP270 programmer, the purge timing is initiated as soon as the firing rate motor is commanded to drive to the high fire position (10-X made). At the end of the purge timing, the firing rate motor is driven to the low fire position (10-12), **and the control waits an additional 30 second (minimum) until the low fire start interlock is proven closed (M-D)**. See to the table below on dipswitch functions.

Purge timing of the EP270W is set at 30 seconds. It cannot be extended.

DIPSWITCH 6 - 3-P RUNNING INTERLOCK CIRCUIT PROVEN OPEN TO START:

Dipswitch 6 provides the option that requires the 3-P running interlock circuit to be proven open at the start of the operating cycle. If this option is enabled (switch 6 is Up), the 3-P running interlock circuit **must be open** at the start of the operating cycle (L1-13 circuit closed). If this option is enabled and the 3-P circuit is closed at the start of the operating cycle, the control will hold for one (1) minute waiting for the 3-P circuit to open. If after one (1) minute, the 3-P circuit does not open, the control will lockout. The EP260, EP265, EP270 programmers are shipped with this option disabled (switch 6 is Down). The Prove 3-P Open To Start option is disabled on the EP270W and cannot be changed.

DIPSWITCH POSITION						TERMINAL TIMINGS				
U = UP		DN = DOWN				PROGRAMMER TYPE	PTFI		MTFI	
1	2	3	4	5	6		T - 5	T - 6	T - 5	T - 6
I N A C T I V E	I N A C T I V E					EP260	10	10	10	15
						EP270	5	10	—	10
						EP261	10	10	10	30
						EP265	10	10	—	15 *
		Dn	Dn	Dn		30 sec.	Selectable High Fire Purge Timing Low Fire Purge Timing added to High Fire Purge 30 sec. (min.)			
		Dn	Dn	Up		60 sec.				
		Dn	Up	Dn		90 sec.				
		Dn	Up	Up		2 min.				
		Up	Dn	Dn		5 min.				
		Up	Dn	Up		10 min.				
		Up	Up	Dn		15 min.				
		Up	Up	Up		30 min.				
					Dn	Prove 3-P Open	DISABLED			
					Up	Prove 3-P Open	ENABLED			
* During MTFI, terminal 6 is energized for 5 seconds (pilot stabilization) before energizing terminal 7 for 10 seconds (EP265 only).										

PROGRAMMER AND DISPLAY MODULE COMPATIBILITY

Two display modules are compatible with the FLAME-MONITOR control system (P/N's ED500 [obsolete] and ED510). The ED500 was an 8 character LED display, that physically mounted in the card rack of the EB700 chassis. The ED510 is a 2 line by 16 character LCD with keypad to provide both current and historical information pertaining to the operation of the control. Refer to Bulletin ED-5101 for a complete description of the features and capabilities of the ED510 display module. Programmers with an Engineering code of 28 or later (e.g.: 9414-28) are compatible with both the ED510 and ED500 display module. Programmers with an Engineering code before 28 are only compatible with the ED500 display. The ED510 display physically mounts onto the front cover of the EP260 programmer (Engineering code 28 or later).

RJ STYLE CONNECTORS

ED510 Display

Programmer modules (with Engineering code 28 or later) include an RJ45 style connector to connect to an alpha-numeric display (P/N ED510). The ED510 can snap onto the front cover of the programmer module or be mounted remotely (See Bulletin E-8101— Remote mounting kit). The ED580 cable (provided with ED510 Display) then plugs into the RJ style connectors on both the ED510 display and programmer module

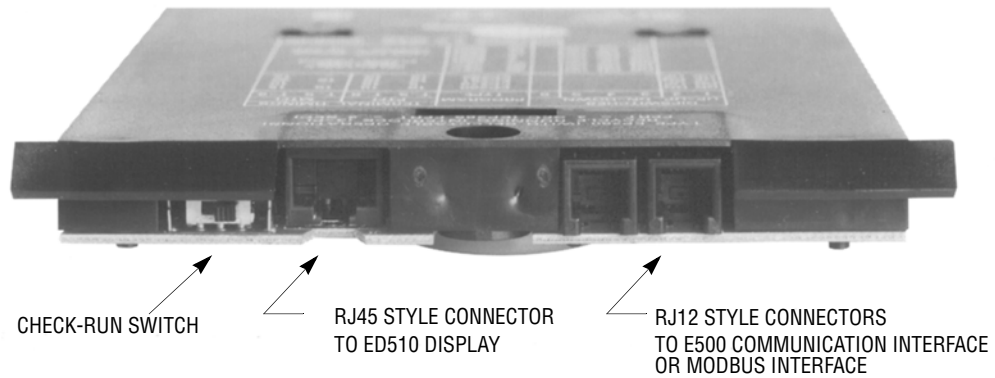

Check-Run Switch

The Check-Run switch is located on the top of the EP Programmer Module and can be used to stop the control in its firing sequence at any time except MTFI. If moved during the MTFI period, it is not functional and automatic programming continues. It aids in the set-up and adjustment of the burner linkages, pilot assembly, etc. Refer to Bulletin E-1101 for a complete description of the Check-Run Switch.

E500 Communication Interface

Programmer modules (with Engineering code 28 or later) include two (2) RJ12 style connectors to connect to the RS485 Interface on the E500 Communication Interface in a multi-drop wiring configuration with other devices. Refer to Bulletin E-5001. Up to six (6) each of EP programmers and E340 Boiler Controls (12 total) can be wired in a multi-drop configuration.(Unit address 00 to 31). When connected in this manner to the E500, a unit address must be set on each programmer module connected to the RS485 interface. (See Unit Address). Programmers can also be connected to the E500 via the standard flat ribbon cables (ED550).



UNIT ADDRESS

There are two methods to program the unit address when the programmer module is connected to the E500 via the RS485 interface:

Method One (ED510 display only)

1. Press the SCRL key until the screen displays PROGRAM SETUP
2. Press the MODE key and the screen displays PROGRAMMER EP260 (or appropriate model).
3. Press the SCRL key until the screen displays UNIT ADDRESS #00 (or appropriate address).
4. Every time the RESET key is held down for 1 second and then released it will increase the address by one.
5. Maximum address is 15. Then the address will roll over to 00.

Method Two (ED510 or ED500)

1. Make sure the control is not in a lockout condition. If so, press the reset button.
2. Open the operating control (term L1-13).
3. Move the "Check-Run" switch to the Check position.
4. The display will indicate Unit Address 00 (or the current address).
5. Every time the reset button is held down for 1 second and then released it will increase the address by one.
6. Maximum address is 31. Then the address will roll over to 00.

COMMUNICATIONS

Refer to bulletin E-1101 for complete description of the Modbus Communication capability.

OPERATION

The EP260, EP265, and EP270 programmers also provide the operator with a constant status indication as well as diagnostic information. Programmer with an Engineering code of 28 or later (e.g. 9414-28) are compatible with either the ED510 (2 line x 16 character LCD display with keypad for local access to historical information) or ED500 (8 character LED display). For purposes of illustration for this bulletin, we will be looking at the EP260 Programmer functions and messages associated with the ED510 display module. The ED500 display messages will be abbreviated versions of the ED510. Refer to the suggestions shown in bulletin E-1101 before proceeding to power the Fireeye FLAME-MONITOR system. Items such as scanner installation, short circuit tests and safety information should be reviewed.



CAUTION: On initial power-up and on restarts following a power failure, the control will perform self-test diagnostics for 15 seconds.

Start-Up (Normal Cycle)

Note: For direct spark ignited oil burners, substitute the words Main-Oil Valve for Pilot Valve.

1. Constant 120 VAC should be available to the L1-L2 terminals only on the wiring base.
2. The operating control circuits (L1-13) will close, signaling the burner to start its firing sequence.
3. Assuming the fuel valve end switch (13-3) is closed, the burner/blower motor (terminal M) circuit is energized. The running interlock (limit) circuit (3-P) will close (e.g.: all limits, interlocks, etc. are proven).



- The firing rate motor (Modulator Motor) is driven toward the high purge open damper position (10-X ckt. made) and the prepurge interval of 30¹ seconds is initiated. The ED510 will display:

PURGE 00:05
HIGH FIRE PURGE

- When the prepurge is completed, the firing rate motor is driven toward the low purge damper position (10-12 ckt. made). The ED510 will display:

PURGE 00:35
LOW FIRE PURGE

- Following the minimum 30 second delay (to permit the firing rate motor to get to the low fire position), the control will wait for the low fire switch (M-D) to close. When it closes, the trial for ignition sequence will start. If after ten minutes, the M-D circuit is not closed, the control will lockout.

- The trial for ignition period begins with Terminal 5 and 6 being energized simultaneously. This is known as PTFI (Pilot Trial for Ignition). The ED510 will display:

PTFI 00:02
IGNITION TIMING

This period is ten seconds in duration. If no flame is detected after ten seconds, the control will de-energize Terminals 5 and 6 and lockout. When flame is detected during this 10 second period, the ED510 will display:

PTFI 20
FLAME SIGNAL

FLAME SIGNAL	
0-9	NOT ACCEPTABLE
10	MINIMUM ACCEPTABLE
20-80	NORMAL

- With flame proven at the end of PTFI, the main flame trial for ignition (MTFI) period begins. Terminal 7 is energized. The ED510 will display:

MTFI 35
FLAME SIGNAL

Terminal 5 is de-energized 10 seconds later and Terminal 6 is de-energized after another 5 seconds.

- The firing rate motor is now sent to the auto position (10-11 ckt made) and is under the command of the proportional controller. The ED510 will display:

AUTO 40
FLAME SIGNAL

Note: Trial-for-ignition timings depend on the programmer selected. The timing charts on pages 3 and 4 point out the differences in the EP260, EP265, and EP270.

Normal Shutdown

- When the operating control circuit (L1-13) opens, the main fuel valve is de-energized. The firing rate motor is driven to the low purge position (10-12 ckt made).
- Following a 15 second post purge, the burner/blower motor is de-energized.
- The burner is now off and the ED510 will display

STANDBY
L1-13 OPEN

Note: Current burner history can be displayed with the ED510 display module by use of the keypad provided.

¹ Purge timing is selectable via dipperswitches.



ED510 BACKLIT DISPLAY

With current ED510's (Engineering code 3 or higher), the LED display backlight remains ON at all times. With earlier ED510 versions, the backlight will be lit when the L1-13 (operating control) circuit is closed, and OFF when the L1-13 circuit is open. With the earlier displays, depressing any key will light the display for three (3) minutes.

LOCKOUTS

When a safety shutdown occurs, the control will display a message indicating LOCKOUT and the reason for the lockout. The alarm circuit (Terminal "A") will be energized. The non-volatile memory will remember the status of the control even if a power failure occurs. By depressing the reset button on the display, the control can be reset. The button must be held down for one second and then released. Very little force is required to do this. Do not press hard.

Safety Shutdown

1. If the low fire start circuit (M-D) or running interlock circuit (3-P) have not closed after a ten (10) minute "Hold" period during prepurge, the control will lockout and the blower motor will be de-energized. If the interlock circuit opens during the trial for ignition period or firing period, all fuel valves will be de-energized and the control will initiate a 15 second post purge **and then recycle**. See above for condition of running interlock circuit during prepurge.
2. If dipswitch 6 is in the "Up" position (3-P prove open to start-enabled), and the 3-P circuit is closed at the start of the operating cycle, the control will hold for one (1) minute waiting for the 3-P circuit to open. If, after one (1) minute, the 3-P circuit does not open, the control will lockout.
3. If pilot flame is not detected during the 10 second trial for ignition period, the pilot valve and ignition transformer will be de-energized and the control will lockout on safety.
4. If main flame is not detected at the end of the main flame trial for ignition period, all fuel valves will be de-energized and the control will lockout on safety.
5. If the main flame fails during a firing cycle, all fuel valves will be de-energized within 4 seconds after loss of flame signal and the control will lockout on safety.
6. If flame is detected when the operating control (L1-13) is open, the control will wait sixty (60) seconds and then lockout if flame is still present. If the operating control closes and flame is detected during purge, the blower motor (term M) remains energized and the purge sequence is put on hold. If the flame signal goes away within sixty (60) seconds, the control will proceed with a normal start-up. If flame signal is still present after sixty (60) seconds, the control will lockout.

NOTE: Manual Reset is required following any safety shutdown.

NOTE: Depressing and releasing the reset button during a cycle will cause the control to shut the burner down and recycle.

Lockout Messages Refer to bulletins ED-5101 or E-1101 for a complete list of all messages associated with the ED510 display.

Lockout History Lockout history and burner history can be displayed via the ED510 keypad and display. Refer to bulletin ED-5101 or E-1101.



TYPICAL WIRING ARRANGEMENT FOR PILOT IGNITED BURNERS USING THE EP260, EP265, EP270

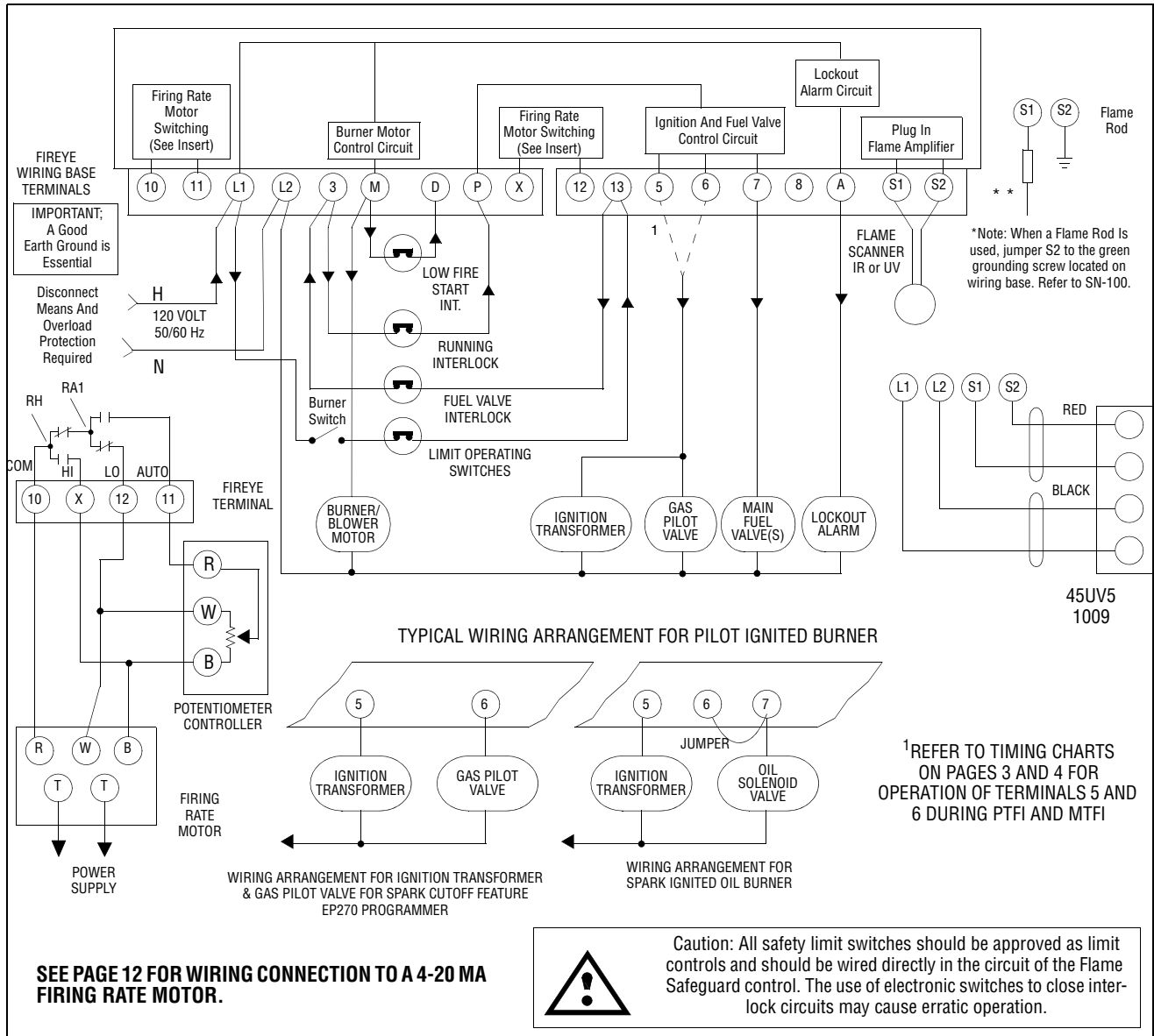

AUXILIARY DEVICE IN M-D-8 CIRCUIT AT FLAME MONITOR CONTROL

The function of the low fire start and interlock circuit internally in a Fireye Flame Monitor unit is accomplished by highly reliable solid state electronic circuitry. This prohibits the connection of power consuming devices (i.e. lamps, annunciators, relays, timers, etc.) to the D or 8 terminals.

FLAME MONITOR ELECTRICAL NOISE

In applications which appear to have excessive electrical noise, it may be helpful to add an electrical noise suppressor to the power supply of the control circuit.



We recommend Fireeye P/N 60-2333 on EB700 with less than Engineering Code 3.

Wiring E110 FLAME-MONITOR to a 4-20mA Firing Rate Damper Motor

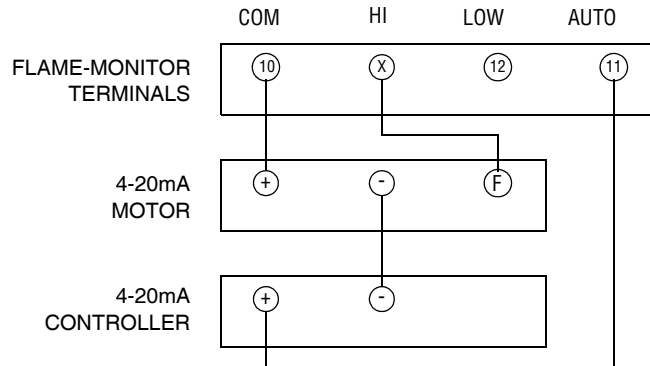

NOTICE

When Fireeye products are combined with equipment manufactured by others and/or integrated into systems designed or manufactured by others, the Fireeye warranty, as stated in its General Terms and Conditions of Sale, pertains only to the Fireeye products and not to any other equipment or to the combined system or its overall performance.

WARRANTIES

FIREYE guarantees for *one year from the date of installation or 18 months from date of manufacture* of its products to replace, or, at its option, to repair any product or part thereof (except lamps, electronic tubes and photocells) which is found defective in material or workmanship or which otherwise fails to conform to the description of the product on the face of its sales order. **THE FOREGOING IS IN LIEU OF ALL OTHER WARRANTIES AND FIREYE MAKES NO WARRANTY OF MERCHANTABILITY OR ANY OTHER WARRANTY, EXPRESS OR IMPLIED.** Except as specifically stated in these general terms and conditions of sale, remedies with respect to any product or part number manufactured or sold by Fireeye shall be limited exclusively to the right to replacement or repair as above provided. In no event shall Fireeye be liable for consequential or special damages of any nature that may arise in connection with such product or part.



FIREYE®
3 Manchester Road
Derry, New Hampshire 03038
www.fireeye.com

EP-2601
APRIL 3, 2013
Supersedes August 6, 2007